





NOTICE DE MONTAGE 30040733 - CHAISE HAUTE MELBOURNE

A Rondelle M6  4 PCS	B Vis M6*40  4 PCS	C  1 PC		
1  1 PC	2  1 PC			

1

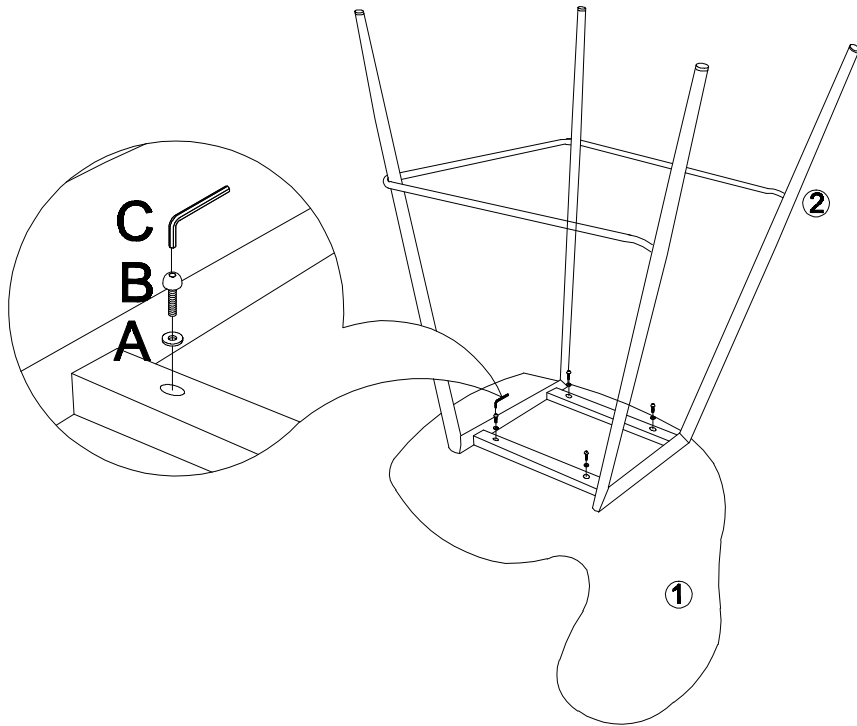

2

